

No	a*b	X
1	2096x498	2
2	2068x551	1
3	476x550	4
4	2068x551	2
5	1001x551	1
6	1001x551	1
7	2096x497	2

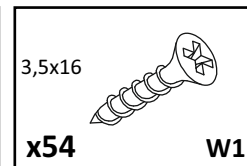

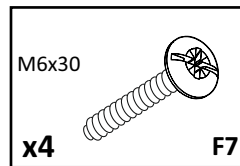

1

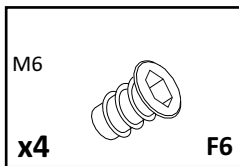
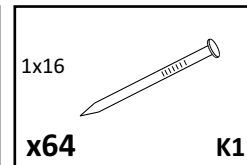
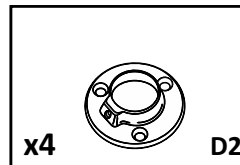
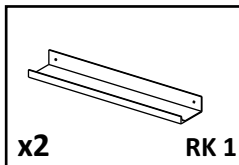
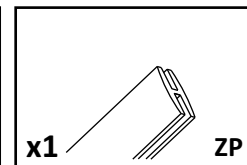
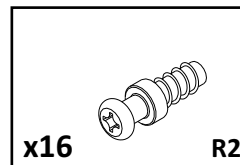
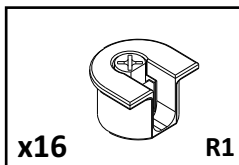
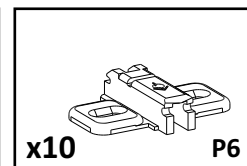
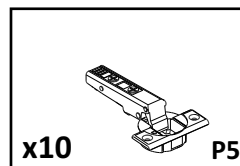
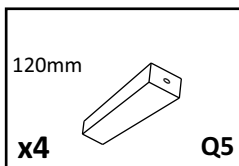
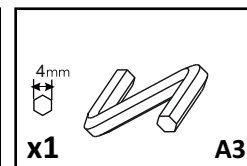
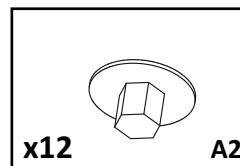
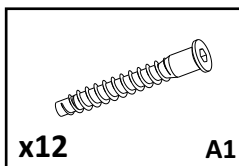
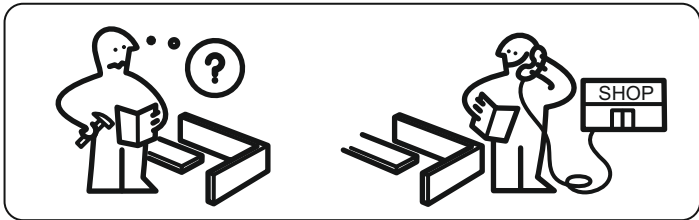
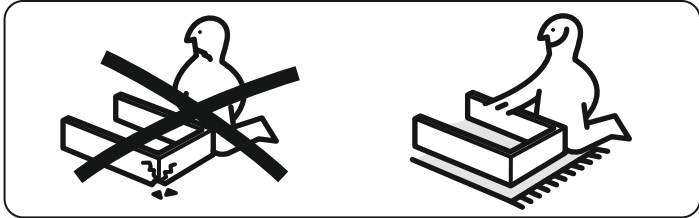
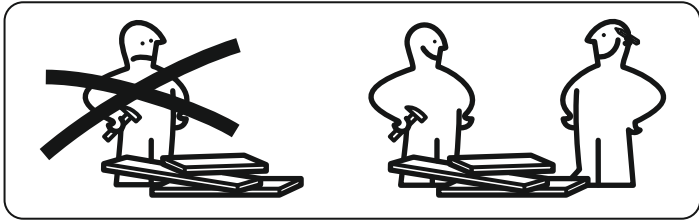
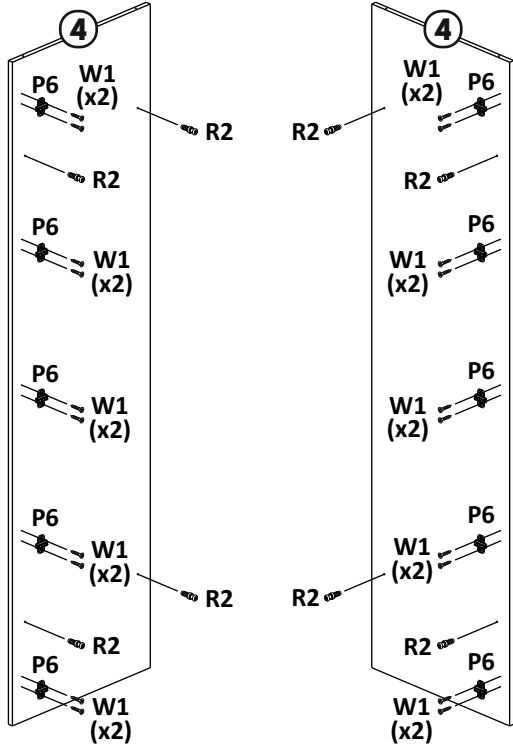
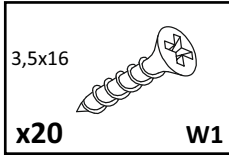
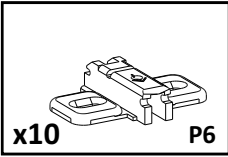

2

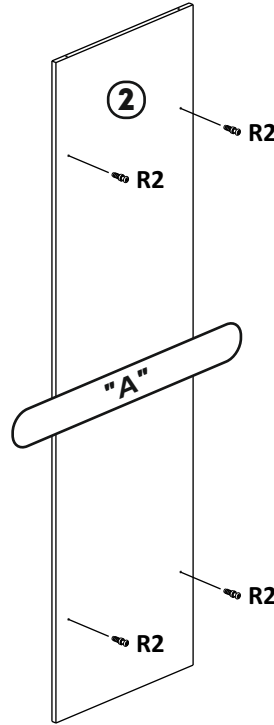
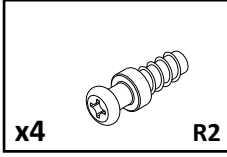

3

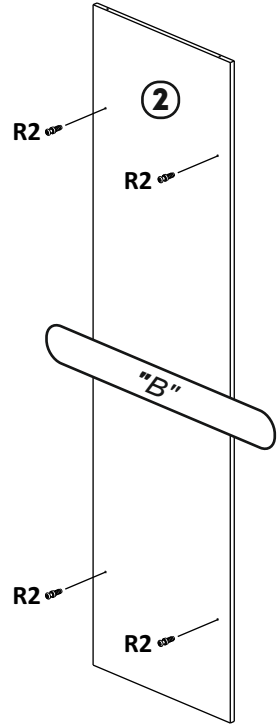
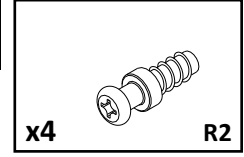

4

120mm

x4

Q5

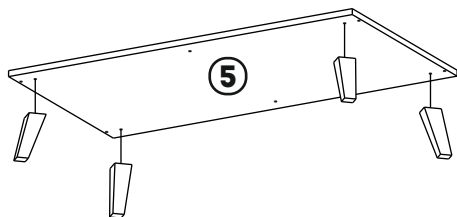
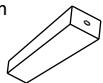

F7

F6

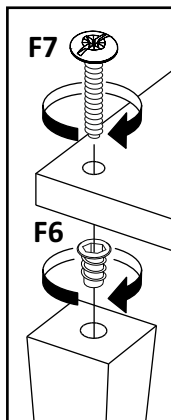
**6**

x12

A1

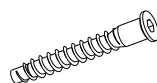

x12

A2

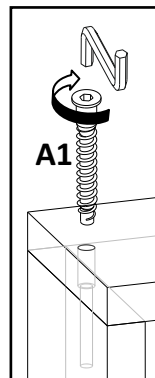

A1

**5**

x4

R1

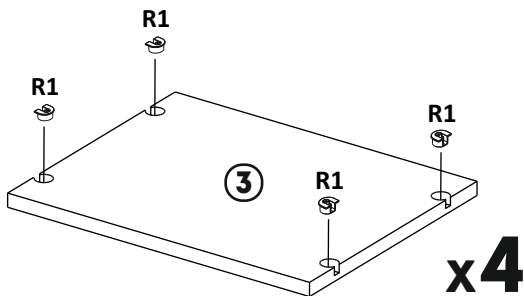
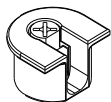
**x4**

x12

A1

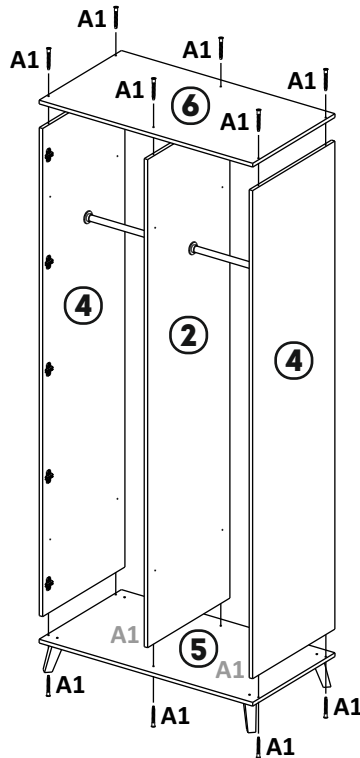

D2

W1

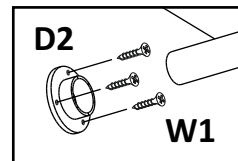

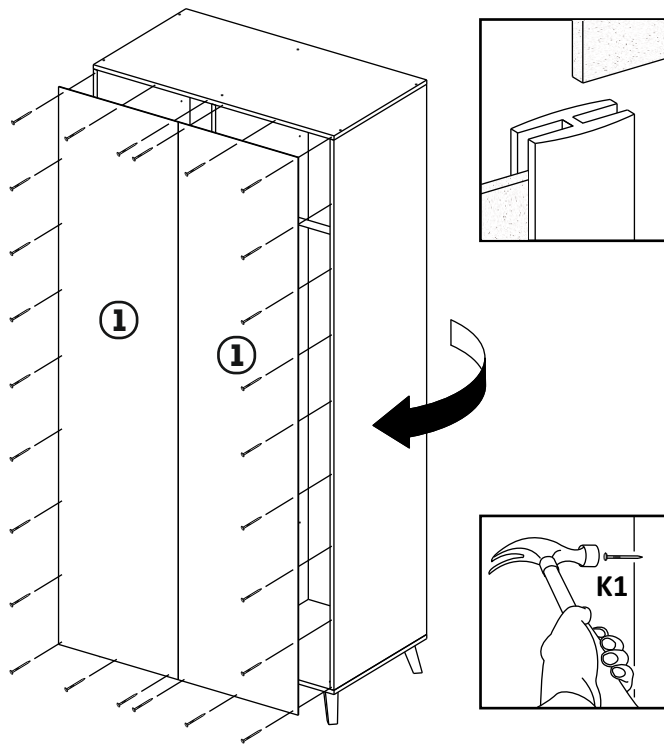
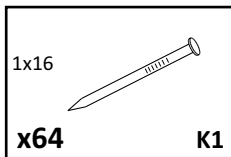
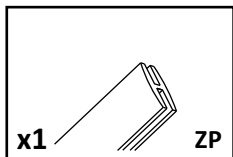
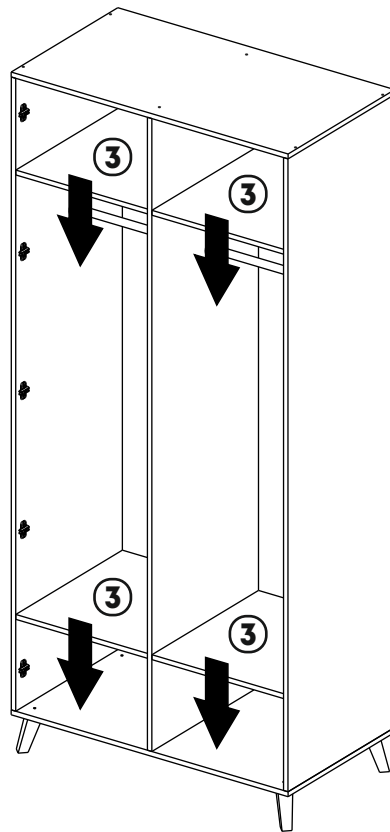
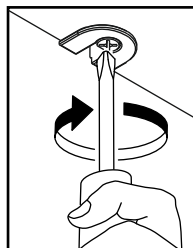
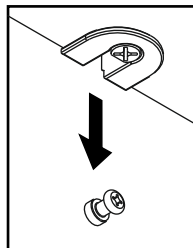
7**8**

9

3,5x16

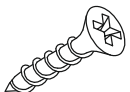

x10

W1

x5

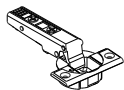

P5

x2

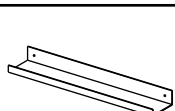

RK 1

x2

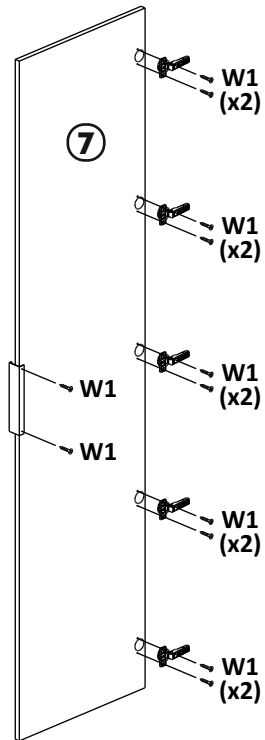

10

